

Megger[®]

S1-552/2
5kV Digital Insulation Tester

USER MANUAL

 **SAFETY WARNINGS****Safety Warning must be observed during use.**

- The circuit under test **must** be switched off, de-energised, isolated and checked to be safe **before** insulation test connections are made. **Make sure** the circuit is not re-energised whilst the instrument is connected.
- Circuit connections **must** not be touched during an insulation test.
- After completing a test, capacitive circuits **must** be completely discharged before disconnecting the test leads. Capacitive charges can be lethal.
- Tested items should be firmly shorted out with a shorting link, after discharge, until required for use. This is to guard against any stored dielectric absorption charge subsequently being released thereby raising the voltage to potentially dangerous levels.
- The voltage indicator and automatic discharge features should be regarded as additional safety features and not a substitute for normal safe working practice.
- It is rare, but in certain circumstances, breakdown of the circuit under test may cause the instrument to terminate the test in an uncontrolled manner, possibly causing a loss of display while the circuit remains energised. In this event, the unit **must** be turned off and the circuit discharged manually.
- Test leads, including crocodile clips, must be in good order, clean and with no broken or cracked insulation.
- The instrument should not be used if any part of it is damaged.
- Insulation testing in wet weather conditions might be hazardous. It is recommended that this instrument is not used in these circumstances. If this is unavoidable, the user must take all necessary precautions.
- This instrument is not intrinsically safe and must not be used in hazardous atmospheres.

NOTE**THE INSTRUMENT MUST ONLY BE USED BY SUITABLY TRAINED AND COMPETENT PERSONS.**

Users of this equipment and/or their employers are reminded that National Health and Safety Legislation requires them to carry out valid risk assessments of all electrical work so as to identify potential sources of electrical danger and risk of electrical injury such as inadvertent short circuits. Where the assessments show that the risk is significant then the use of fused test leads may be appropriate.

CONTENTS

Safety warnings	2	Test mode summary	15
Introduction	4	Insulation resistance 'IR' test	15
General description	4	Breakdown mode / burn mode	15
Features	4	Alarm limit mode	15
Cleaning	4	Step voltage 'SV' test	16
Power lead and battery charging	5	Polarisation index 'PI' test, and dielectric absorption ratio 'DAR' test	16
Instrument controls and indicators	6	Dielectric discharge 'DD' test	16
Power On/Off button	7	Measurements above 100 G Ω	17
Test voltage ▲ and ▼ buttons	7	Circuit block diagram	18
Test start / stop button	7	Specifications	19
Ω/I button	7	Accessories	20
⊙ button	10	Repair and warranty	21
Fn button	10		
Mode button	10		
Timer ▲ and ▼ buttons	11		
Record button	11		
Recording to on-board memory	11		
Downloading results	11		
Deleting results	11		
Recording to a PC	12		
High voltage warning LED	12		
Line input present LED	12		
Test terminals	12		
Guard terminal	12		
RS232 / USB connections	13		
Battery bar graph	13		
Voltage at terminals	13		
Timer indicator	13		
Digital display	13		
Analogue display	14		
Secondary display	14		
Pre-Test / during test key action table	14		

Symbols used on the instrument are:



Caution: risk of electric shock



Caution: refer to accompanying notes



Equipment protected throughout by Double Insulation (Class II)



Equipment complies with current EU directives.

Terms used in this manual

The word **must** is used to indicate that the instructions following should be followed under all circumstances. Failure to follow these instructions could result in damage to the instrument and / or a hazard to the operator.

The word **should** is used to indicate that the instructions indicate best practice.

INTRODUCTION

General Description

The S1-552/2 is a microprocessor controlled 5 kV insulation tester offering measurement capability of up to 15 TΩ. The instrument performs automatic tests and has data storage and data retrieval facilities.

Polarization index and dielectric discharge tests are performed automatically, and test duration and voltages can be adjusted according to user preference for these tests. A step voltage test can be performed automatically, with a default voltage of 1 kV, and test duration of 5 minutes. It is possible for the user to set different voltages and test durations for the step voltage test.

The S1-552/2 can be powered from the mains supply or by its own internal rechargeable battery, which provides for at least 6 hours of continuous testing with a 100 MΩ load. A battery level indicator on the LCD display indicates battery capacity. Connecting power to the mains supply connector will automatically charge the battery whether the instrument is switched 'on' or 'off', except during testing. A high level of internal isolation allows the instrument to be used while the unit is supplied from the mains. An internal battery management system switches the instrument off after ten minutes of inactivity. If the battery approaches a very low state of charge the instrument turns itself off, and mains power must be applied before the instrument can be used again. Recorded test results and settings will not be lost when the instrument is switched off.

A comprehensive LCD display shows resistance, current, capacitance, time constant, voltage, timer measurements, and figure of merit measurements such as polarisation index.

Features

- Continuous resistance or current measurement on main display.
- Optional resistance, current, or figure of merit measurements on secondary display.
- Standard test voltages – 250 V, 500 V, 1 kV, 2.5 kV, 5 kV
- Non-standard test voltages – selectable between 50 V and 1 kV in 10 V steps, and selectable between 1 kV and 5 kV in 25 V steps.
- Test modes include insulation resistance, polarisation index, step voltage and dielectric discharge.
- The dielectric absorption ratio is automatically calculated if the corresponding timers are set.
- Either burn or breakdown selectable in insulation resistance mode.
- Insulation 'Alarm Limit' available in insulation resistance mode.
- Programmable timers include a main test duration timer, plus T1 and T2 timers for time resistance method type tests.
- Load capacitance and time constant measurements – displayed at end of test.
- LCD backlight.
- Data storage, data retrieval and real time data output.
- USB or RS232 communications.
- Battery level / charge level indicator.

Cleaning

Disconnect the instrument and wipe it with a clean cloth slightly dampened with soapy water or Isopropyl alcohol (IPA).

POWER LEAD AND BATTERY CHARGING

If the power lead supplied is not suitable for your mains connection, do not use an adaptor. Always use a power lead fitted with the correct plug.

The instrument is fitted with a two-pin IEC60320 power inlet. Most power leads are made with three-core cable, so the ground connection will not be used.

Power lead connection table

Connection	UK/International	USA
Earth/Ground	Yellow/Green	Green
Neutral	Blue	White
Live (Line)	Brown	Black

If using a fused plug, ensure that it is fitted with a 3 Amp fuse.

The instrument can be powered from 85 - 265 Vrms a.c. at 50/60 Hz. The battery will charge as long as the mains supply is connected, except when a test is in progress. The power On/Off button has a green LED, which illuminates when mains power is present. For optimum battery life, charge the battery after each use. A completely exhausted battery will take 14 hours to recharge.

INSTRUMENT CONTROLS AND INDICATORS

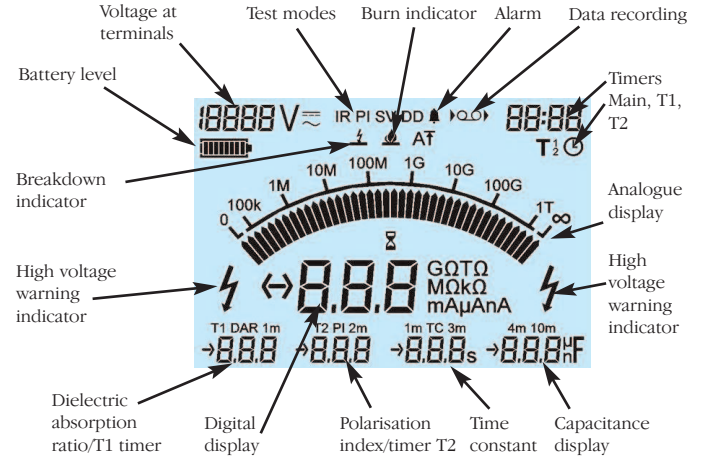
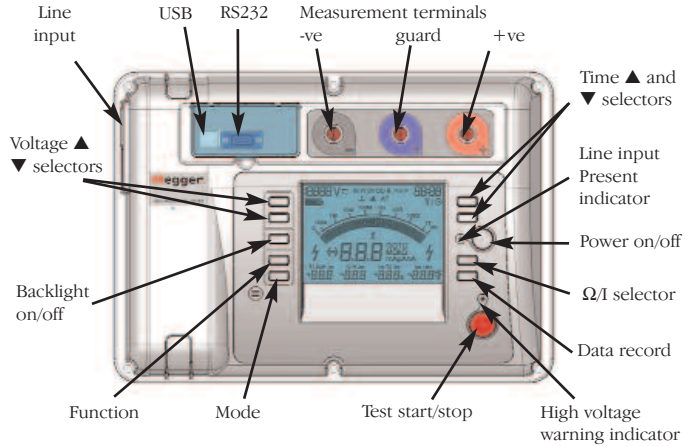

Power On/Off button

The instrument will only turn on if this button is pressed, held and then released when the display responds. The instrument will not turn on if the button is released before the display responds, or if the button is held down for too long. This is a safety feature to prevent the instrument being inadvertently turned on.

The instrument is turned off either by pressing the button again, or if the instrument is running on the battery, by timing out after 10 minutes of inactivity.

Upon switching the instrument on the display will first show 'Ini' while it undergoes a self-checking routine. When Ini disappears, the instrument is ready for use.

Test voltage ▲ and ▼ buttons

Using these buttons one of five test voltages can be selected: 250 V, 500 V, 1 kV, 2.5 kV, and 5 kV. The selected voltage is shown on the display.

A non standard voltage between 50 V and 5 kV can be selected by holding down the 'Fn' function button whilst operating the buttons. The selectable voltage is adjustable in 10 V steps between 50 V and 1 kV, and adjustable in 25 V steps between 1 kV and 5 kV. An auto repeat facility is enabled when the button is held down, allowing faster travel through the range.

If there is an external voltage greater than 50 V on the test leads, the high voltage warning indicators are flashed, and the display shows this voltage instead. The instrument will not perform a test if this voltage is greater than 50 V.

During a test the display shows the actual voltage on the test leads. If the test voltage is changed during a test, the new test voltage will be displayed briefly.

When the test has stopped, the display continues to show the voltage present on the test leads. Pressing either test voltage ▲ or ▼ button will then display the test voltage immediately before the end of the test.

Test start / stop button

A test will only start if this button is pressed, held and then released as soon as the red high voltage warning indicator LED lights. The LCD and red LED high voltage warning indicators flash when the test starts.

A test will not start if the button is released before the red LED shows, or pressed continuously for longer than 5 seconds. This is a safety feature to prevent a test being started inadvertently.

The presence of a voltage greater than 50 V on the test leads is indicated with flashing high voltage warning indicators. Testing is disabled if the external voltage exceeds 50 V.

Testing will stop if the test start / stop button is pressed again, the preset test time is reached, or, if the unit is not in burn mode, insulation breakdown is detected.

When a test has finished, the instrument will discharge the load, which may take some time. The operator must always check the load has been discharged before touching the test leads.

Ω/I button

Pressing this button toggles the digital and secondary displays. The details available when scrolling the secondary display will depend upon the test mode selected, whether timers T1 and T2 have been set, and the duration of the test. The digital display toggles between insulation resistance and current.

In the 'IR', 'PI', and 'DD' modes the secondary display initially shows the PI (polarity index), DAR (dielectric absorption ratio), and, on completion of the test, the TC (time constant) and capacitance measurements. Toggling the display shows insulation resistances and currents.

In the 'SV' (step voltage) mode, the secondary display toggles between insulation resistances and currents.

Figures 1 to 4 illustrate the display status for sequential 'Ω/I' key presses in the different modes.

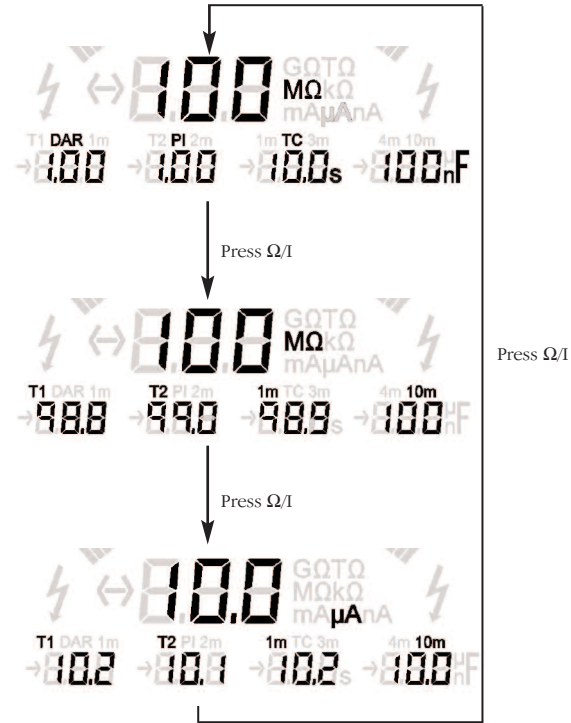

Figure 1 - The result of an insulation resistance test (IR)

Test settings: T1 and T2 times set in order to measure the DAR

Test conditions: test runs for longer than 10 minutes as this is required for a PI reading.



Figure 2 - The result of a polarity index test (PI)

Test settings: T1 and T2 times set in order to measure the DAR

Test conditions: timer defaults to 10 minutes, as this is required for a PI reading



Figure 3 - The result of a dielectric discharge test (DD)

Test settings: T1 and T2 times set in order to measure the DAR

Test condition: test runs for longer than 10 minutes as this is required for a PI reading.

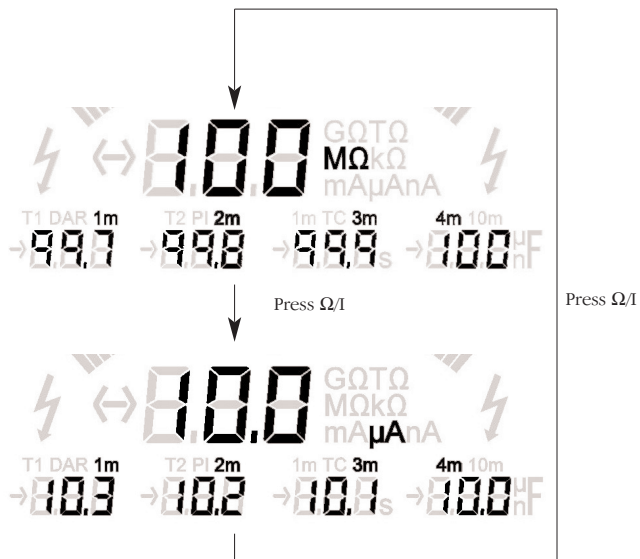

Figure 4 - The result of a step voltage (SV) test

Test condition: timer defaults to 5 minutes and test voltage defaults to 1000 V.



button

Pressing this button toggles the display backlight on and off.

Fn button

The function button when pressed allows other keys to perform another function. This is summarized in the table below. 'V▲' and 'V▼' represent the

test voltage buttons. 'T▲' and 'T▼' represent the timer buttons.

Button Press	Function	Comment
Fn + V▲	Increment in 10 V steps	Voltage range between 50 and 1000 V
Fn + V▼	Decrement in 10 V steps	Voltage range between 50 and 1000 V
Fn + V▲	Increment in 25 V steps	Voltage range between 1000 and 5000 V
Fn + V▼	Decrement in 25 V steps	Voltage range between 1000 and 5000 V
Fn + T▲ or T▼	Cycle through timers	Select main timer, T1 or T2
Fn + Mode	Cycle through IR modes	Select breakdown, burn or alarm limit for IR test
Fn + 	Download mode	See 'Downloading results'
Fn + 	Clear stored data	The 'record' button is pressed twice

Mode button

Press down on the 'MODE' button to cycle through and select the test mode. Modes of test to be chosen from include an insulation resistance 'IR' test, a polarization index 'PI' test, a step voltage 'SV' test, and a dielectric discharge 'DD' test.

The insulation resistance 'IR' test operates in either 'burn' or 'breakdown' mode, with an option of setting a resistance threshold 'alarm limit'. These modes can be cycled through and selected by holding down the Fn button

and pressing the Mode button.

Timer ▲ and ▼ buttons

The main timer can be set up to 99mins 59secs. The T▲ button increments the time, and the T▼ button decrements the time in ten seconds steps. An auto repeat facility allows the time to be set more quickly. Setting a time of 00:00 disables the timer. With the timer disabled a test has to be manually stopped.

The minimum timer setting is 15 seconds for test voltages of 1000 V or more, and 30 seconds below this.

To select timer Tmain, T1 or T2, hold down the Fn button whilst repeatedly pressing the T▲ or T▼ buttons. To set the selected timer, release the Fn button, and then use the T▲ or T▼ buttons.

Note: T2 cannot exceed the time on main timer unless it is disabled (00:00). T1 cannot exceed the time on T2.

Record button

This button is used to start and stop recording. Recording can only be activated before testing. When data recording is enabled the 'record' symbol flashes.

Data is stored in solid-state memory and under normal circumstances will maintain its integrity for in excess of ten years, but may rarely be corrupted or lost by external influences such as transients and static discharge. Megger Limited cannot accept responsibility for any losses of data. Regular downloading to a PC using software such as Download Manager will substantially reduce any such risk.

Recording to on-board memory

Press the record button to start and stop recording. When data recording is enabled the record symbol will flash on and off repeatedly. Recording can only be activated before testing commences. Results are stored at 15, 30, 45 and 60 seconds. After 60 seconds, at minute intervals up to 10 minutes. After 10 minutes, results are recorded at 5 minute intervals until the test terminates. At each interval the recorded data will contain selected voltage, test time elapsed, voltage applied, leakage current, and insulation resistance.

Downloading results

Connect the instrument to the RS232 / USB port of a PC running Download Manager. Refer to section 'RS232 / USB connection' for set up details. Start Download Manager on your PC, select the S1-552 driver and right click the icon. Select 'Download'.

Switch the instrument on and wait until initialisation is complete. Press the function key along with the record key. The instrument now displays 'dld' to indicate download mode. Press and hold down test button until download begins, shown by analogue display lighting clockwise.

Results will not be erased during this operation and so may be downloaded repeatedly.

Deleting test results

Switch the instrument on and wait until initialisation is complete. Hold down the function key and press the record key twice. The instrument now displays 'clr' to indicate clear mode. Press and hold down test button until clear process begins, shown by analogue display lighting anti clockwise. Press the MODE button to exit without deleting the results.

Recording to a PC

While carrying out a test, the instrument will output the test voltage, test current and resistance every second. Refer to section 'RS232 / USB connection' for setup details. Connect the instrument to the RS232 / USB port of the PC. The data may be captured with Microsoft® HyperTerminal or another suitable programme.

High voltage warning LED

This is a red LED next to the TEST button on the front panel. The LED flashes when the voltage on the test inputs exceeds 50 V.

Line input present LED

This is a green LED next to the power On/Off button on the front panel. It is illuminated whenever the mains power is connected.

Test terminals

There are three test terminals marked +, - and G. These terminals are designed to accept only the test leads supplied. Shutters across the terminals prevent accidental ingress of dirt and other objects. Test lead plugs interlock with the shutters and are released by rotating the test lead plug a quarter turn.

The Guard terminal is explained below and is only used in cases where surface leakage currents need to be eliminated. Most measurements use just the + and - terminals. The instrument's internal voltage generator drives the + terminal with respect to the - terminal, current being measured in the - terminal.

Guard terminal

For basic insulation tests and where there is little possibility of surface leakage affecting the measurement, it is unnecessary to use the guard

terminal i.e. if the insulator is clean and there are unlikely to be any adverse current paths. However in cable testing for example, there may be surface leakage paths across the insulation between the bare cable and the external sheathing due to the presence of moisture or dirt. Where it is required to remove the effect of this leakage, particularly at high testing voltages, a bare wire may be bound tightly around the insulation and connected via the third test lead to the guard terminal 'G'.

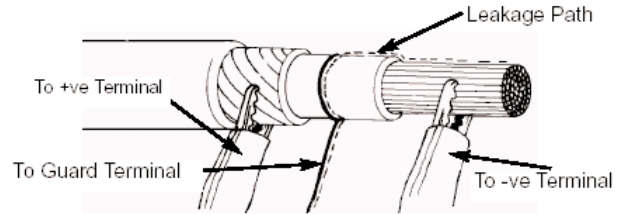

The guard terminal is at the same potential as the negative terminal. Since the leakage resistance is effectively in parallel with the resistance to be measured, the use of the guard causes the current flowing through surface leakage to be diverted from the measuring circuit. The instrument therefore reads the leakage of the insulator, ignoring leakage across its surface.

The display will show 'FUS' if the internal guard terminal fuse is found to have blown. The instrument must be switched off to clear the message before further testing is permitted. The fuse should be replaced by an authorised repairer. The instrument may be used in the mean time if the guard terminal not used. Refer to notes regarding measurements above 100 G Ω on page 17.

RS232 / USB connection

Data can be transferred to a PC via an RS232 or USB port. If using the RS232 port, use the null modem cable supplied. The RS232 settings are 38400 Baud, 8 data bits, 0 parity, 1 stop bit, no flow control (handshake).

If using the USB port, ensure that the USB driver supplied on the accompanying product CD has been installed **BEFORE** connecting the instrument. Installation instructions are also to be found on the CD.

Programmes such as Megger Download Manager may be used to download the results stored in memory. Programmes such as Microsoft® HyperTerminal may be used to record real time data.

Battery bar graph

This is a battery symbol on the LCD display comprising 4 pairs of segments. The battery is monitored continuously when the instrument is turned on. The charge remaining in the battery is shown in the table below.

Fully charged battery



50% charged battery



Tests cannot be started, and the battery may fail at any time.



Symbol flashes when there is not enough charge for a test. The instrument then turns itself off.

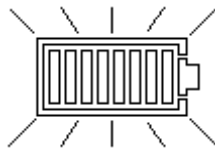

When mains power is present the indicator shows the battery is being charged by animating the segments of the bar graph.

Voltage at terminals

The test voltage will default to that selected in the previous test. If the instrument has been switched off since the previous test, the test voltage defaults to 250 V.

If there is an external voltage greater than 50 V present, this will be displayed regardless of changes made to the test voltage. In this case the instrument will not perform a test. The high voltage warning indicators flash, and the beeper sounds to warn of the hazard until the external voltage becomes less than 50 V.

When testing, the voltage displayed is the voltage present at the test terminals of the instrument. If the test voltage is changed, by pressing either of the test voltage ▲ and ▼ buttons during a test, the new test voltage is displayed momentarily.

After testing, the voltage displayed is the voltage present on the terminals. To see what the voltage was immediately prior to the end of the test, press either test voltage ▲ or ▼ buttons.

Timer indicator

The timer shows minutes and seconds. At the start of a test the timer will start from zero and at the end of a test it will stop. The duration of the last test remains on the display until another test is started.

Digital display

The digital display shows the resistance or current being measured during a test. The Ω/I button toggles between the two. After a test the display

shows the last measurement made until the timer or voltage test settings are changed or the test start/stop button is pressed.

Analogue display

This simulates an analogue meter movement to give the user a better "feel" for how a measurement is progressing. The analogue display shows resistance only.

The display is also used to indicate how 'result download' and 'deletion of results' is progressing.

Secondary display

This part of the display shows the results of 'time resistance' method tests.

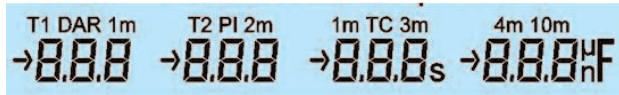

'Pre-Test / During test' Key action table.

Button press	Key action		Fn + Key action	
	Pre-test	During test	Pre-test	During test
V▲/V▼	Increase / decrease the test voltage in major steps	Increase / decrease the test voltage in major steps (IR only)	Increase / decrease the test voltage in minor steps	Increase / decrease the test voltage in minor steps (IR only)
V▲ AND V▼	Sets voltage to 500V	Show set voltage		
T▲/T▼	Increase / decrease the time of the selected timer	Display set time on main timer briefly	Select main timer T1 or T2	Display time set for main timer, T1 or T2 briefly
T▲ AND T▼	Reset timer to zero	Display set time on main timer briefly	Reset selected timer to zero	Display set time on main timer briefly
Mode	Select Test Mode		Cycle through IR modes	
Ω/I	Cycle through results display of last test completed	Cycle through results display of current active test		
Record	Turn recording On/Off		Select download or clear stored data	

V▲ and V▼ represent the test voltage buttons. T▲ and T▼ represent the timer buttons.

TEST MODE SUMMARY

Press the 'MODE' button to cycle through and select the test mode. Modes of test to be chosen from include an insulation resistance 'IR' test, a polarization index 'PI' test, a step voltage 'SV' test, and a dielectric discharge 'DD' test. If timers T1 and T2 are set, the instrument will automatically calculate the dielectric absorption ratio 'DAR' of the insulation. PI, DAR, and IR values are automatically stored and displayed if the data is available, irrespective of the selected test mode. At the end of a test the instrument can be made to display either the insulation resistances, insulation currents or ratios plus capacitance measurements by using the 'Ω/I' toggle button. See section 'Ω/I button' for cycling through results and toggling units.

Insulation Resistance 'IR' test

This is the default mode in which the instrument powers up. This test mode measures insulation resistance continuously at the selected voltage. The test voltage may be varied during an 'IR' test by pressing the test voltage ▲ or ▼ buttons. The test duration can be set using the 'main timer'. The test will finish automatically after this time has elapsed. On test completion, insulation capacitance and the time constant associated with it is calculated and displayed.

$$\text{Time Constant (TC)} = R_{\text{ins}} \times C_{\text{ins}}$$

If timers T1 and T2 are set, the instrument will calculate and display the DAR value under the segment 'DAR'. On completion of the test, the instrument will display the insulation resistance measured at these times under the segment symbols 'T1' and 'T2'. If the test runs for longer than 10 minutes, the instrument will calculate the 'polarisation index'. This value will be displayed under the display segment symbol 'PI'. On completion of the test, the instrument will display the insulation resistance recorded at 1 minute and 10 minutes under the segment symbols '1m' and '10m'.

Pressing the 'Ω/I' button toggles the display to show the insulation resistances, insulation currents, DAR and PI ratios, and capacitance. The resistances and currents will be displayed under the 'T1', 'T2', '1m' and '10m' segment headings, the ratios under the 'DAR' and 'PI' segment headings. The capacitance reading is indicated by its units of either 'nF' or 'μF'. Refer to section 'Ω/I button'.

Breakdown mode / burn mode

The insulation resistance 'IR' test operates in either the 'Burn' or 'Breakdown' mode of operation. The default mode is breakdown. To change mode press and hold the function button, then press and release the mode button repeatedly until the desired mode is indicated by the flashing symbol on the display. Release the function button to select it.

In the breakdown mode the 'Breakdown Indicator' will be illuminated – refer to page 6. In this mode the test will automatically terminate should the insulation break down to prevent damage to the insulation under test.

In the burn mode the 'Burn Indicator' is illuminated – refer page 6. The burn mode disables the normal breakdown detection and enables the insulation test voltage to continue even after breakdown of the insulation. This will enable the location of the failure to be seen and heard. Due to the potential damage that could occur, the unit produces two long beeps when starting a test with burn mode activated.

Alarm limit mode

The insulation resistance 'IR' test has an option of setting an alarm limit. If this mode is selected, the instrument will beep should the resistance reading exceed a user selectable threshold. To set the limit, hold down the function button, then press and release the mode button repeatedly until the 'A ↑' symbol is flashing on the display. Use the timer ▲ and ▼ buttons

to set the resistance threshold between the limits of 10 k Ω and 15 T Ω . Release the function button to save the current limit. Adjusting the alarm threshold level automatically activates the alarm limit mode. This is indicated by the 'A \uparrow ' symbol turning solidly on.

To toggle the alarm limit mode on/off, hold down the function button, then press and release the mode button repeatedly until the 'A \uparrow ' symbol is flashing on the display. Release the function key to toggle.

Step voltage 'SV' test

This is a test based on the principle that an ideal insulator will produce identical readings at all voltages, while an insulator which is being over stressed, will show lower insulation values at higher voltages. The main timer and test voltage settings can be adjusted if desired from their default values of 5 minutes and 1 kV respectively. During the test the applied test voltage incrementally steps by one fifth of the test voltage setting (final value) every minute, for 5 minutes, taking successive measurements until the final voltage is reached. Readings for the first 4 recorded values are displayed under the consecutive segment headings '1m' to '4m'. The 5 minute reading is displayed by the main display.

If the range of measured insulation between readings is too wide for the instrument to display, then those readings too small compared to the final reading will be represented by '---'.

Polarisation index 'PI' test, and dielectric absorption ratio 'DAR' test

The 'PI' test is a particular example of a time/resistance method, which takes the ratio of the insulation measured at 1 minute and at 10 minutes. Good insulation generally shows an increase in resistance over a 10 minute period. Readings for contaminated insulation are fairly constant because

any absorption effects are masked by high leakage currents. On completion of the test the polarisation index is displayed under the segment heading 'PI'.

$$\text{Polarisation Index (PI)} = \frac{R_{10 \text{ min}}}{R_{1 \text{ min}}}$$

The 'Dielectric Absorption Ratio' is the term applied to the polarisation index using other time intervals set by T1 and T2.

If timers T1 and T2 are both set, then the insulation resistance measured at these times is also recorded. These are displayed together with the calculated dielectric absorption ratio under the T1, T2, and DAR segments respectively.

The instrument can be made to display either the insulation resistances, insulation currents or ratios plus capacitance measurements by using the Ω/I toggle button. See section ' Ω/I button' for cycling through results and toggling units.

$$\text{Dielectric Absorption Ratio (DAR)} = \frac{R_{T2 \text{ min}}}{R_{T1 \text{ min}}}$$

Dielectric discharge 'DD' test

The 'DD' test is a diagnostic insulation test that allows ageing, deterioration, and voids in the insulation to be assessed. The result is dependent on the discharge characteristic, so the internal condition of the insulation is tested, largely independent of any surface contamination. On discharge the capacitive component of the discharge current decays from a high value with a relatively short time constant of a few seconds. The

other current component, comprising the released absorption current, decays from a lower value with a relatively long time constant of up to several minutes. If this component of the discharge current is large (>7 @ 500 V test voltage) then the insulation condition is poor.

The main timer will default to 30 minutes, which is normally sufficient time for full absorption to take place in an insulation material. The default test voltage is set to 500 V. The 'DD' test requires the instrument to measure the discharge current 1 minute after the removal of the test voltage. At this time the capacitive current should be insignificant compared with the released absorption current. On completion of the test, the instrument uses this measurement along with the test voltage and calculated capacitance to produce a figure of merit indicating the quality of the insulation.

$$\text{Dielectric Discharge (DD)} = \frac{I_{1 \text{ min}}}{V \times C}$$

where I is the measured current expressed in milliamps (mA), V is the test voltage in Volts (V), and C is the measured capacitance in Farads (F).

Measurements above 100 GΩ

Measurements up to 100 GΩ can be made without any special precautions, assuming that the test leads are reasonably clean and dry. The guard lead can be used to remove the effects of surface leakage if necessary. When measuring resistances above 100 GΩ, the test leads should not be allowed to touch each other, or any other object since this will introduce leakage paths. Sharp points at the test lead connections should also be avoided since this will encourage corona discharge.

The output is isolated, and so will float relative to ground such that the positive terminal is at plus half of the test voltage, and the negative terminal is at minus half of the test voltage with respect to ground. Leakages therefore occur between the positive terminal and ground, between the negative terminal and ground, and directly between the positive and negative terminals. These leakages have a significant effect and can occur through the air itself.

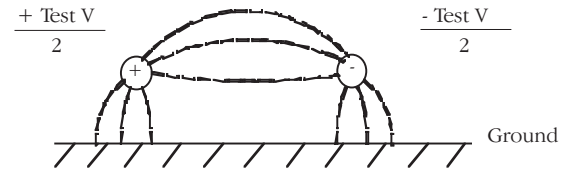

If the guard lead is connected to ground, then since the negative terminal is at the same voltage as the guard terminal, the leakage into the negative terminal will be considerably reduced. This will improve accuracy because the current flowing into the negative terminal is measured by the instrument and used to calculate resistance. This technique is only permissible if the item under test is isolated from ground. "Isolated" in this context means insulated by a resistance of at least 5 MΩ for the positive

terminal, or at least 10 kΩ for the negative terminal.

Conversely, if the positive terminal is grounded, then the negative terminal will be at a voltage equal to the test voltage relative to ground, which will result in an increase in leakage current, and worsening of measurement accuracy.

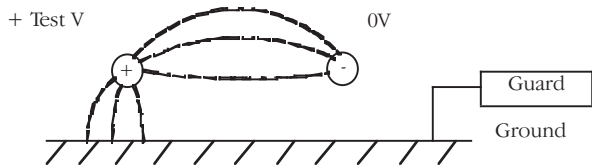

When making measurements above 100 GΩ therefore, the user should ground the Guard Lead where possible, otherwise parallel leakage paths may occur.

Alternatively, screened leads are available as an optional accessory from Megger. The lead to the negative terminal is fully screened. The screen is plugged into the Guard terminal, diverting any stray leakage currents. This considerably improves measurements made with a floating output, where the leads might touch each other or anything other than the test piece.

Circuit block diagram

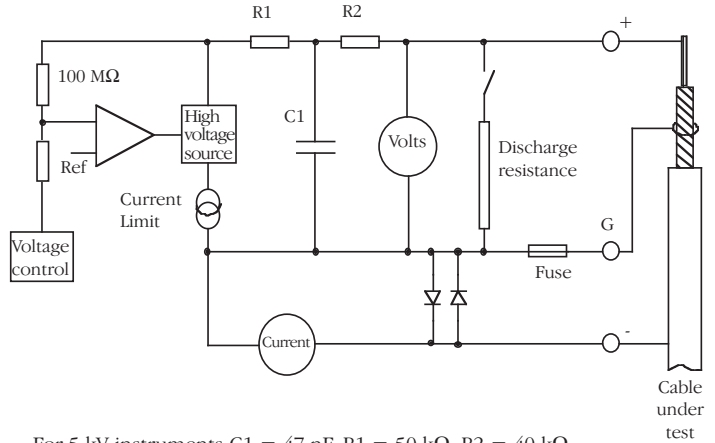

For 5 kV instruments C1 = 47 nF, R1 = 50 kΩ, R2 = 40 kΩ

For 10 kV instruments C1 = 15 nF, R1 = 156 kΩ, R2 = 110 kΩ

SPECIFICATIONS

Voltage input range

85-265 V rms, 50/60Hz, 60 VA

Battery life

Typical capacity is 6 hours continuous testing at 5 kV with a 100 M Ω load

Test voltages

250 V, 500 V, 1 kV, 2.5 kV, 5 kV ranges, adjustable in 10 V steps from 50 V to 1 kV, and 25 V steps from 1 kV to 5 kV

Accuracy (23°C, 5 kV)

$\pm 5\%$ @ 1 T Ω

$\pm 20\%$ @ 10 T Ω

Guard

2% error guarding 500 k Ω leakage with 100 M Ω load

Display range

Digital display 10 k Ω to 15 T Ω (3 digits)

Analogue display 100 k Ω to 1 T Ω

Short circuit/charge current

5 mA 5 kV

Capacitor charge time

<1.5 seconds per μF at 5mA to 5 kV

Capacitor discharge time

<120 ms per μF to discharge from 5 kV to 50 V

Capacitance measurement (500 V minimum test voltage)

10 nF to 50 μF (dependent on test voltage)

Capacitance measurement accuracy (23°C)

$\pm 5\%$ ± 5 nF

Voltage output accuracy (0°C to 30°C)

+4%, -0% ± 10 V of nominal test voltage at 1 G Ω load

Current measurement range

0.01 nA to 5 mA

Current measurement accuracy (23°C)

$\pm 5\%$ ± 0.2 nA at all voltages

Interference rejection

1 mA per 250 V up to a maximum of 2 mA

Timer range

Counts up to 99 minutes and 59 seconds from start of test

15 second minimum setting for test voltage ≥ 1000 V

30 second minimum setting for test voltage <1000 V

Test regimes

Auto IR, PI, SV, DD

DAR is calculated automatically if timers T1 and T2 are set

Interface

RS232: 38400 Baud, 8 data bits, 0 parity, 1 stop bit, no flow control.

USB

Data storage

Data stored: selected voltage, test time elapsed, voltage applied, leakage current, and insulation resistance. The PI, DAR, capacitance, time constant and DD values are also stored if available at the end of the test. Megger Download Manager may be used to transfer this data to a PC.

Data output

Real time serial data output once per second of the test voltage, test current, and resistance

ACCESSORIES

Lead set

Three flexible silicon insulated leads with compact clamp

Safety

Meets the requirements of EN61010-1:2001 CAT IV 600 V

EMC

Meets the requirements of EN61326-1:1998 for use in heavy industrial areas.

Operating temperature

-20°C to 50°C

Storage temperature

-25°C to 65°C

Ingress protection (lid closed)

IP65

Humidity

90% RH non-condensing at 40°C

Dimensions

305 x 194 x 360 (mm) (12 x 7.6 x 14.2 inches)

Weight

7.1 kg (16lb) approx.

Order Code

Included Accessories

3 m lead set, medium size insulated clips	6220-820
User guide on CD-ROM	2000-213
RS232 cable	25955-025
UBS cable	25970-041

Optional Accessories

HV test lead sets

3 x 3 m with un-insulated small clips	8101-181
3 x 8 m with un-insulated small clips	8101-182
3 x 15 m with un-insulated small clips	8101-183
3 x 10 m with medium insulated clips	1000-441
3 x 15 m with medium insulated clips	1000-442
3 x 3 m with large insulated clips	6220-811
3 x 10 m with large insulated clips	1000-443
3 x 15 m with large insulated clips	1000-432

Control circuit test lead set

2 x 3 m with small insulated clips	6220-822
------------------------------------	----------

Screened HV test leads

1 x 3 m, with 5 kV screened un-insulated small clips	6220-835
1 x 15 m, with 5 kV screened un-insulated small clips	6311-080

REPAIR AND WARRANTY

The instrument contains static sensitive devices, and care must be taken in handling the printed circuit board. If an instrument's protection has been impaired it should not be used, but sent for repair by suitably trained and qualified personnel. The protection is likely to be impaired if for example, it shows visible damage, fails to perform the intended measurements, has been subjected to prolonged storage under unfavourable conditions, or has been subjected to severe transport stresses.

NEW INSTRUMENTS ARE GUARANTEED FOR 1 YEAR FROM THE DATE OF PURCHASE BY THE USER.

Note: Any unauthorized prior repair or adjustment will automatically invalidate the Warranty.

CALIBRATION, REPAIR AND SPARE PARTS

For service requirements for Megger Instruments **contact:**

Megger Limited	or	Megger
Archcliffe Road		Valley Forge Corporate Centre
Dover		2621 Van Buren Avenue
Kent CT17 9EN		Norristown PA 19403
England.		U.S.A.
Tel: +44 (0) 1304 502 243		Tel: +1 610 676 8579
Fax: +44 (0) 1304 207 342		Fax: +1 610 676 8625

Megger operate fully traceable calibration and repair facilities, ensuring your instrument continues to provide the high standard of performance and workmanship you expect. These facilities are complemented by a worldwide network of approved repair and calibration companies to offer excellent in-service care for your Megger products.

Returning your product to Megger - UK and USA service centres

1. When an instrument requires recalibration, or in the event of a repair being necessary, a Returns Authorisation (RA) number must first be obtained from one of the addresses shown above. You will be asked to provide the following information to enable the Service Department to prepare in advance for receipt of your instrument, and to provide the best possible service to you.
 - Model, e.g. S1-552/2.
 - Serial number, to be found on the underside of the case or on the calibration certificate.
 - Reason for return, e.g. calibration required, or repair.
 - Details of the fault if the instrument is to be repaired.
2. Make a note of the RA number. A returns label can be emailed or faxed to you if you wish.
3. Pack the instrument carefully to prevent damage in transit.
4. Ensure the returns label is attached, or that the RA number is clearly marked on the outside of the package and on any correspondence, before sending the instrument, freight paid, to Megger. Copies of the original purchase invoice and packing note should be sent simultaneously by airmail to expedite clearance through customs. In the case of instruments requiring repair outside the warranty period, an immediate quotation can be provided when obtaining the RA number.
5. You may track the progress of your return on line at www.megger.com

Approved Service Centres

A list of Approved Service Centres may be obtained from the UK address above, or from Megger's website at www.megger.com

Megger Limited
Archcliffe Road, Dover
Kent CT17 9EN England
T +44 (0)1 304 502101
F +44 (0)1 304 207342
E uksales@megger.com

Megger
4271 Bronze Way, Dallas,
Texas 75237-1019 USA
T +1 800 723 2861 (USA ONLY)
T +1 214 333 3201
F +1 214 331 7399
E ussales@megger.com

Megger
Z.A. Du Buisson de la Coudre
23 rue Eugène Henaff
78190 TRAPPES France
T +33 (0)1 30.16.08.90
F +33 (0)1 34.61.23.77
E infos@megger.com

Megger Pty Limited
Unit 26 9 Hudson Avenue
Castle Hill
Sydney NSW 2125 Australia
T +61 (0)2 9659 2005
F +61 (0)2 9659 2201
E ausales@megger.com

Megger Limited
110 Milner Avenue Unit 1
Scarborough Ontario M1S 3R2
Canada
T +1 416 298 9688 (Canada only)
T +1 416 298 6770
F +1 416 298 0848
E casales@megger.com

Megger
501 Crystal Paradise Mall
Off Veera Desai Road
Andheri(w), Mumbai - 400053
Maharashtra
India
T +91 22 26740468
F +91 22 26740465

Programma GmbH
Obere Zeil 2
61440 Oberursel
Germany
T 06171-92987-0
F 06171-92987-19

Programma Electric AB
Eldarvägen 4
Box 2970
SE-187 29 TÄBY
Sweden
T +46 8 510 195 00
F +46 8 510 195 95

Programma Electric AG
Ob. Haselweg 630
5727 Oberkulm
Aargau
Switzerland
T +41 62 768 20 30
F +41 62 768 20 33

Megger products are distributed in 146 countries worldwide.

This instrument is manufactured in the United Kingdom.
The company reserves the right to change the specification or design without prior notice.

Megger is a registered trademark

Part No. S1-552_2_UG_en_V04 0308
www.megger.com

